

Technical leaflet

# AMX<sup>EVO</sup> 35

Shelving elements for shopfittings

# AMX35<sup>evo</sup>

...THE "HISTORY" OF SHELVING REPROPOSES ITSELF AND EVOLVES



The Jordan Group

shopfitting | refrigeration | air conditioning

In its new configuration, **AMX35evo** confirms its up-to-dateness with its new fittings, accessories and finishings, at an extremely competitive price.

**AMX35evo** synthesizes all the best features required of a shelving which is now pleasant to look at and has high quality finishings and performances.

The updated **AMX35evo** is consistent with the most recent standards of environmental preservation and with the safety rules of the Italian Steel Manufacturers Association (ACAI).

## UPRIGHTS

60x22



100x22



34x22

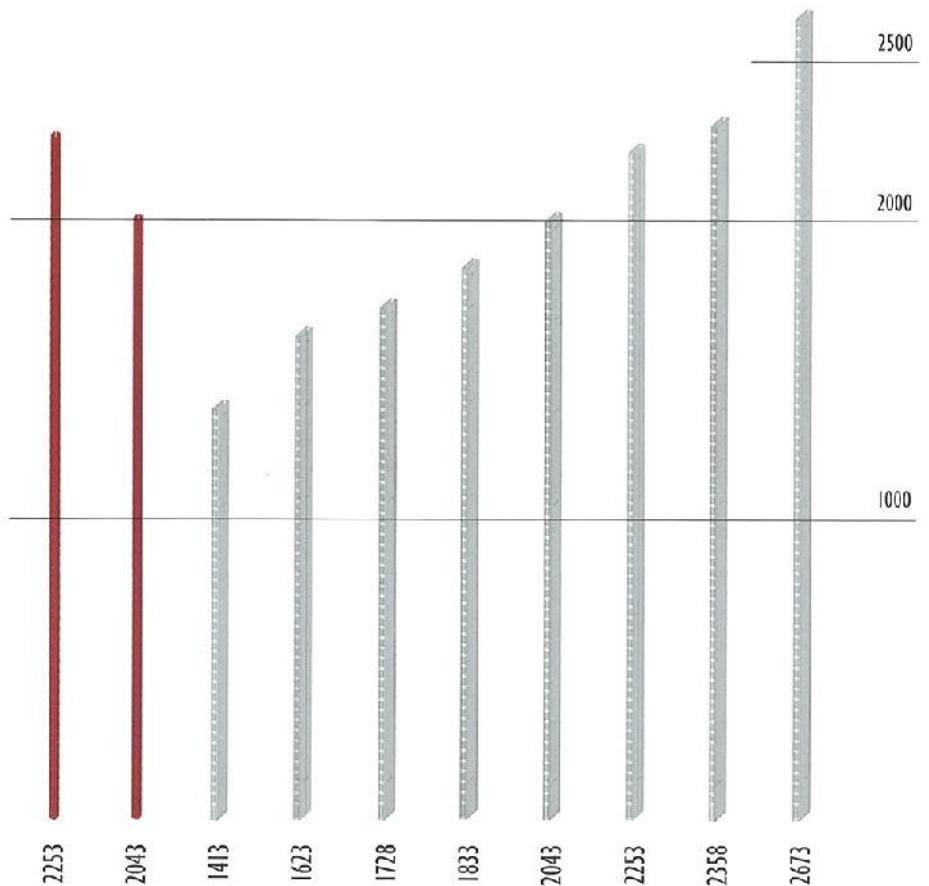
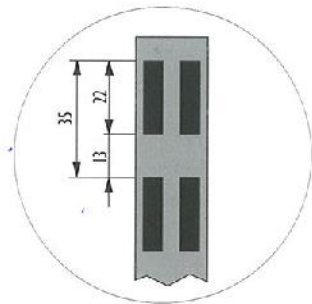

## BACK PANELS

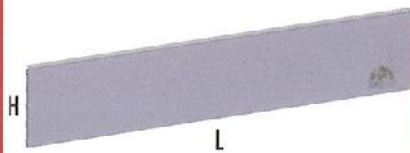

PLAIN

H 315 - L 650-1000-1250-1325

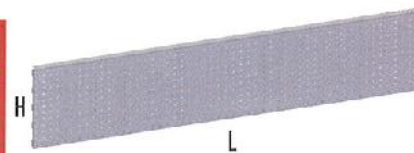

PERFORATED

H 315 - L 650-1000-1250-1325

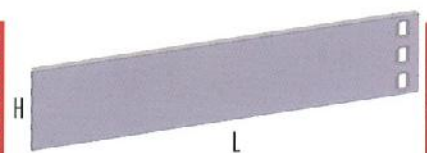

SOCKETS

Sockets H315

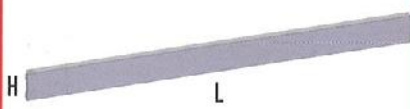

PLAIN

H 105 - L 650-1000-1250-1325



SLATTED

H 105 - L 650-1000-1250-1325 ON DEMAND

## BACK PANELS ASSEMBLY

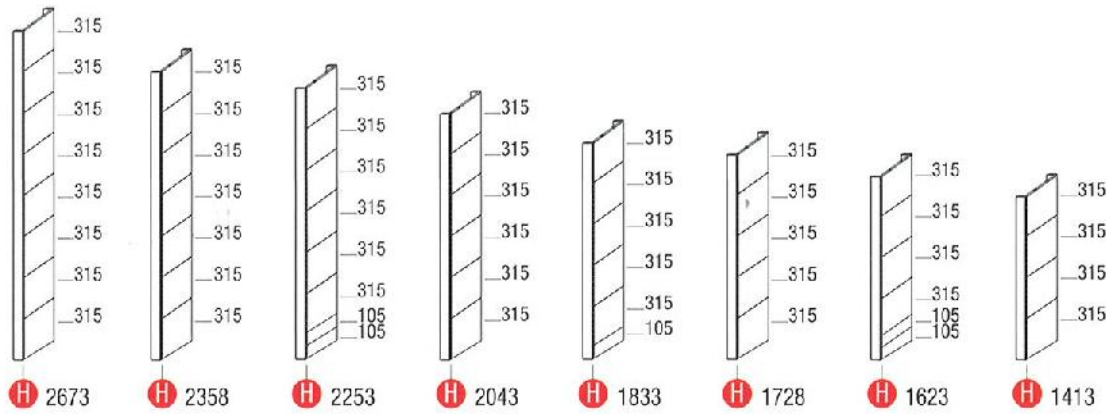

8x315	7x315	6x315	6x315	5x315	5x315	4x315	4x315
--	--	2x105	--	1x105	--	--	--

## PITCH

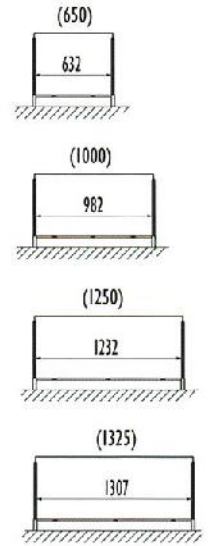

	BASES				BRACKETS					SHELVES			
	BASE 160	4 INCLINAZIONI STANDARD	DRITTA STANDARD	DRITTA RINFORZATA	CRISTALLO SENZA TELAIO	LEGNO	4M	4M 4MAV	4MAV	STANDARD	STONDATO	IN GRIGLIATO	IN CRISTALLO SENZA TELAIO
	CLIP ON BASE 160	STANDARD TILTABLE	STANDARD	STRAIGHT REINFORCED	GLASS SHELF WITHOUT FRAME	WOODEN	4M	4M 4MAV	4MAV	STANDARD	ROUND	GRID	GLASS SHELF WITHOUT FRAME
300	●	●			●	●			●	●			
400	●	●			●					●			●
500	●	●			●			●		●	●	●	●
600	●		●	●						●			
800	●						●			●			



The Jordon Group

shopfitting | refrigeration | air conditioning

# AMX<sup>EVO</sup>35

### METAL FINISHINGS:

- PAINTED
- ARCTIC GREY RAL9002
- PREPAINTED PET
- COATED ARCTIC GREY RAL9002



OPTIONAL



### METAL FINISHINGS:

- STAINLESS STEEL



### GLASSES:

- TRANSPARENT TEMPERED



### TIMBER FINISHINGS:

- "CANALETTO" WALNUT
- "NIAGARA" OAK
- LAMELLAR BEECH





Ed. 01/2010\_Frev01\_GB



The Jordon Group

shopfitting | refrigeration | air conditioning

45100 ROVIGO - ITALY - Via A. Grandi, 24 - Tel. +39 0425 363666 - Fax +39 0425 363600  
[www.intrac.it](http://www.intrac.it) - [info@intrac.it](mailto:info@intrac.it)



L'INTRAC SpA, la cui politica è quella di un continuo perfezionamento, si riserva il diritto di apportare in qualunque momento modifiche ai dati contenuti in questa pubblicazione senza obbligo alcuno di avviso preventivo. • INTRAC SpA, in line with its policy of constant improvement, reserves the right to modify the data included in this catalogue at any time and without notice.